

GRUA TORRE / TOWER CRANE

GRUE A TOUR / БАШЕННЫЙ КРАН /

رافعة برجية / KULE VINÇ

J5510



EN 14439
C25

UNE-EN-ISO 9001

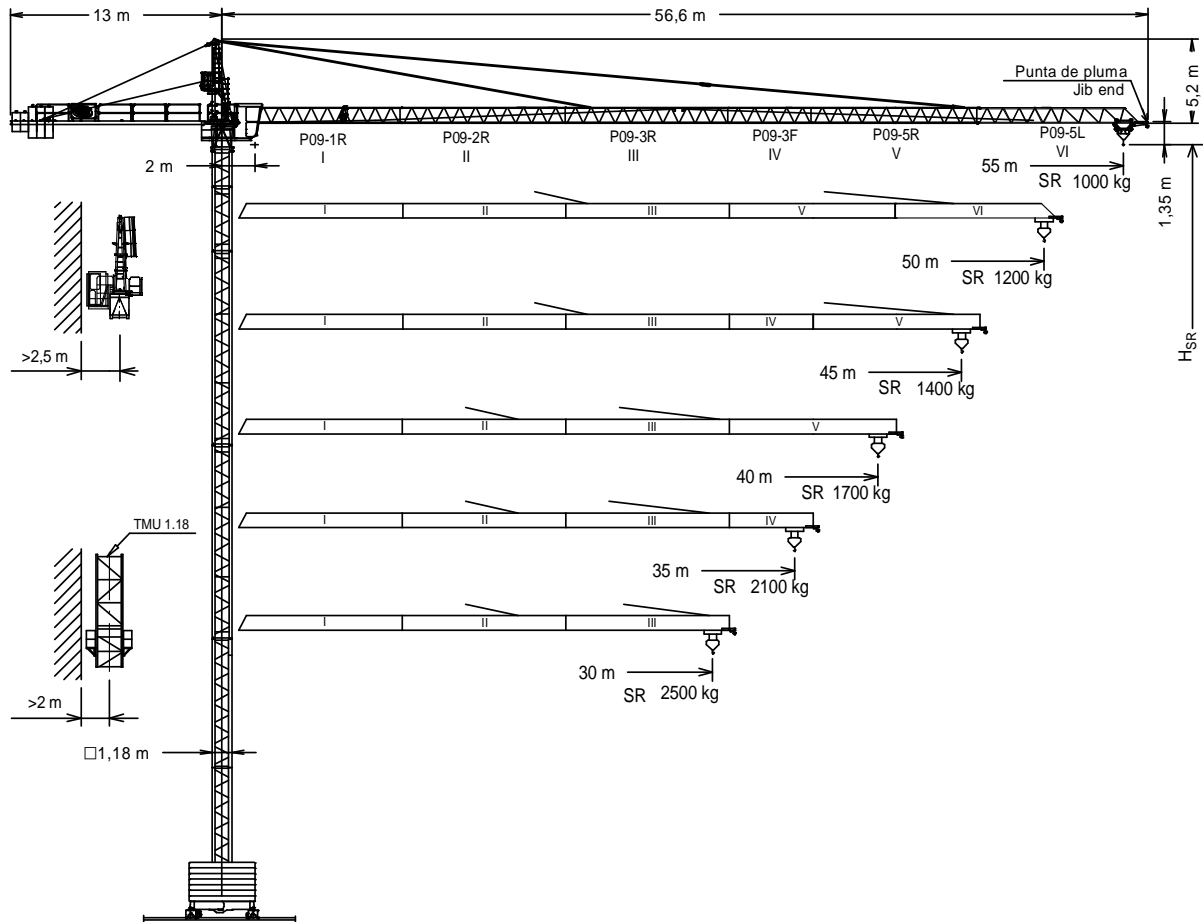

Altura máxima bajo gancho sin arriostrar (m).
Maximum height under hook without fastening (m).
Hauteur maximale sous crochet sans ancrage (m).
Максимальная высота под крюком без крепления (m).
Bağlantısız maksimum kanca altı yüksekliği (m).
أقصى ارتفاع تحت الخطاف بدون ربط (m)

H_{SR} =



H_{SR} - 2 m.

TMU 1.18	202.35.500
P09-1R	162.40.000
P09-2R	162.41.000
P09-3R	162.42.000
P09-3F	157.43.000
P09-5R	162.44.000
P09-5L	155.44.500
Punta de pluma / Jib end*	155.45.000
TR 12	146.30.000
TN 12	146.31.000
TR 8RM	202.30.000
TR 8M	146.30.800
TR 4	800.32.300

TN 4	146.32.000
TN2	146.32.500
BTX 45/BEX 45	137.20.500
BTX 38R/BEX 38R	137.20.000
BTX 38/BEX 38	149.20.000
BEX 45L	155.23.500
BEX 38RL	155.23.800
BEX 38L	155.23.000
ABH 75	152.23.000
ABH 90	146.23.000
AR 12	137.21.000
AN 12	146.21.000
BE 442	146.24.850

* Punta de pluma / Jib end / Pointe de flèche / Конец стрелы / Вор усу / مقدمة الذراع

(H) TRASLACIÓN / TRAVELLING /

TRASLATION / ПЕРЕМЕЩЕНИЕ / RAY YÜRÜYÜŞLÜ / متحركة

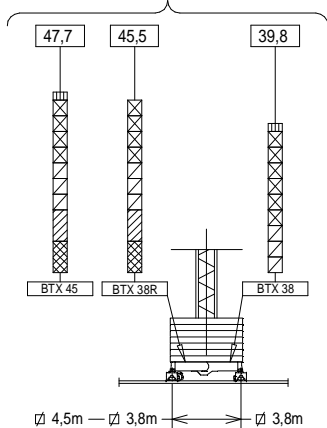

(H) ESTACIONARIA / STATIONARY /

STATIONAIRE / СТАЦИОНАРНОЕ СОСТОЯНИЕ / SABIT / ثابتة

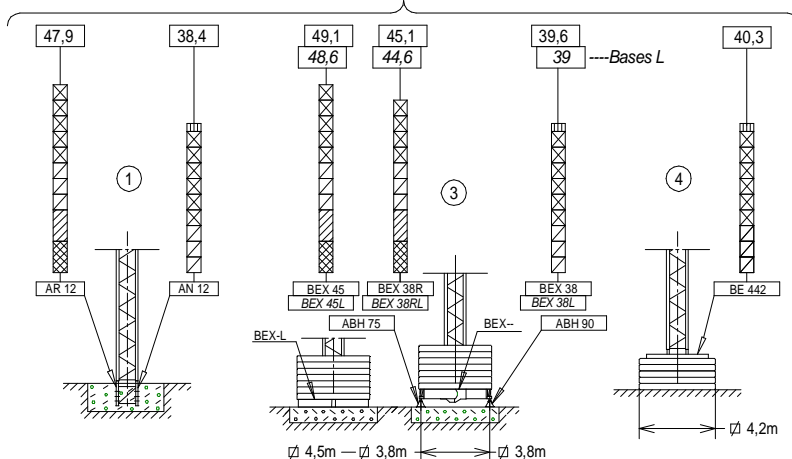

- TN 2
- TR 8RM
- TR 8M
- TN 4
- TN 12
- TR 4
- TR 12

Fecha / Date: 20/01/2016







FEM 1005 - C25



Reservado el derecho a modificaciones sin previo aviso. Declinamos toda responsabilidad derivada de la información proporcionada / Subject to modification, without previous warning. This information is supplied without liability / L'entreprise se réserve le droit de procéder à des modifications sans préavis. Nous déclinons toute responsabilité quant aux informations fournies / Мы оставляем за собой право на внесение изменений без предварительного уведомления. Мы снимаем с себя любую ответственность в отношении предоставленной информации / Önceden bildirilmeksizin değiştirilme hakkı saklıdır. Verilen bilgiler için hiçbir sorumluluk kabul etmemekteyiz















CARGAS / LOADS / CHARGES / НАГРУЗКИ / YÜKLER / الأحمال **J5510**

	SR1 (kg)	Cargas máximas / Maximum loads / Charges maximales / Максимальные нагрузки / Maksimum yük / أقصى حمولة						
		SR2-2000 kg						
	2000 kg @...[m]	Alcance del gancho [m] / Hook reach [m] / Portée du crochet (m) / Радиус действия крюка (m) / Kancanın yüksekliği (m) / مدى الخطاف						
		25	30	35	40	45	50	55
55 m	30,7	2000	2000	1725	1475	1285	1130	1000
50 m	32,3	2000	2000	1830	1565	1365	1200	—
45 m	33,1	2000	2000	1880	1610	1400	—	—
40 m	34,7	2000	2000	1985	1700	—	—	—
35 m	35,0	2000	2000	2000	—	—	—	—
30 m	30,0	2000	2000	—	—	—	—	—

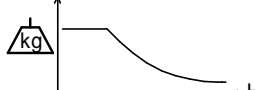

	SR2 (kg)	Cargas máximas / Maximum loads / Charges maximales / Максимальные нагрузки / Maksimum yük / أقصى حمولة						
		SR2-2500 kg						
	2500 kg @...[m]	Alcance del gancho [m] / Hook reach [m] / Portée du crochet (m) / Радиус действия крюка (m) / Kancanın yüksekliği (m) / مدى الخطاف						
		25	30	35	40	45	50	55
55 m	25,2	2500	2055	1725	1475	1285	1130	1000
50 m	26,5	2500	2180	1830	1570	1365	1200	—
45 m	27,1	2500	2235	1880	1610	1400	—	—
40 m	28,4	2500	2355	1980	1700	—	—	—
35 m	29,9	2500	2495	2100	—	—	—	—
30 m	30,0	2500	2500	—	—	—	—	—

CARACTERISTICAS DE MECANISMOS / MECHANISMS FEATURES **J5510**

CARACTÉRISTIQUES DES MÉCANISMES / ХАРАКТЕРИСТИКИ МЕХАНИЗМОВ / MEKANİZMALARIN ÖZELLİKLERİ / الخصائص الآلية

*opcional *optional *en option *опция *opsiyonel *اختياري								
	EC1846 SR2 13,2 kW	EC1856 SR1 13,2 kW	*EC2566VF SR2 18,4 kW	*EC2580VF SR1 18,4 kW	2,8/3,8 / 4,5m TG825VF 2x3 kW	OG1108VF 2x4 kW	TC360 / *TC360VF 1,9 / *1,8 kW	TH1010 9,2 kW
	1,3 2,5 2,5 46 23 5	1,1 2 2 56 28 6	1,3 2,5 0..64 0..32	1,1 2 0..82 0..41	0...25 m/min	0...0,8 r/min sl/min	30/60 m/min *0...30 *30...60 m/min	1 m/min
	H ≤ SR 193 m		SR 189 m		 P_{TOTAL} (EC1846/EC1856 + OG1108VF + TC360) = 23,1 Kw P_{TOTAL} (*EC2566VF/*EC2580VF + OG1108VF + *TC360VF) = *28,2 kW			
					 480V 60Hz EC1846 EC1856 kW +20% TC360 m/min +20% TH1010			

LASTRES INFERIORES / LOWER BALLASTS / LESTS INFÉRIEURS / НИЖНИЙ БАЛЛАСТ / ALT AĞIRLIK TAŞLARI / أثقل **J5510**

	H (m)	18	22	30	40	47,7	49,1
BEX 45 / BTX 45	 4100 kg	6		8	10	14	16
BEX45L		8			10	14	16
BEX 38R / BTX 38R		6	8	10	12	16	----
BEX 38 / BTX 38		6	8	10	12	----	----
BEX 38RL		8		10	12	16	----
BEX 38L		8		10	12	----	----
		H (m)	31,9			40,3	
BE 442	 3450 kg	16			20		





H: Altura bajo gancho / Height under hook / Hauteur maximale sous crochet **Высота под крюком / Kanca altı yüksekliği / الارتفاع أسفل الخطاف**
 Para alturas intermedias tomar el lastre correspondiente a la altura superior / For intermediate heights take the ballast corresponding to the higher height / Pour les hauteurs intermédiaires, opter pour le lest correspondant à la hauteur immédiatement supérieure / Для промежуточных высот возьмите балласт, соответствующий большей высоте / Orta yükseklikler için daha üst bir yüksekliğe karşılık gelen ağırlığı alınız. / لارتفاعات البينية يرجى استخدام الثقل العائد للارتفاع الأعلى. /

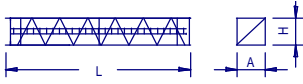
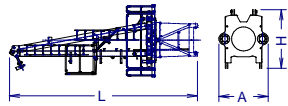
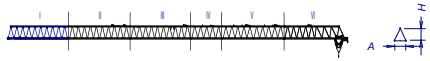
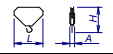

Fecha / Date: 20/01/2016

Reservado el derecho a modificaciones sin previo aviso. Declinamos toda responsabilidad derivada de la información proporcionada / Subject to modification, without previous warning. This information is supplied without liability / L'entreprise se réserve le droit de procéder à des modifications sans préavis. Nous déclinons toute responsabilité quant aux informations fournies / Мы оставляем за собой право на внесение изменений без предварительного уведомления. Мы снимаем с себя любую ответственность в отношении предоставленной информации / Önceden bildirilmezsizin değiştirilme hakkı saklıdır. Verilen bilgiler için hiçbir sorumluluk kabul etmemekteyiz / حقوق التغيير محفوظة دون إشعار مسبق. دون أدنى مسؤولية عن المعلومات المقدمة

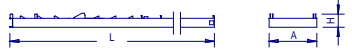
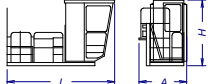
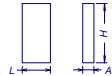
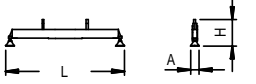
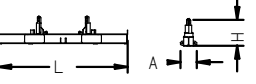
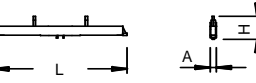
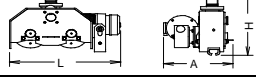
 **FEM 1005 - C25**

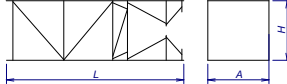
DENOMINACIÓN / DENOMINATION / DÉSIGNATION / НАЗВАНИЕ / AÇIKLAMA / اسم		L [m]	A [m]	H [m]	P / W [kg]		
Torre Tower Tour Башня Kule برج	TR 8RM – TR 8M TR 12 – TN 12 TR 4 TN 4 TN 2		8,07 12,01 3,96 4,09 2,29	1,19 1,19 1,18 1,19 1,19	2575-2515 2840-2780 1070 1055 785		
Conjunto asiento pista, punta de torre, orientación y elevación Slewing table assembly, tower head, slewing and hoisting mechanism Groupe pivot + porte-flèche + mécanisme d'orientation + de levage Сиденье площадки + верхняя секция башни + поворотный механизм + подъемный механизм Göbek +kulenin kafa bölümü+mekanizma+vinç kulesi مجموعة وحدة الدوارن + رأس البرج + آلية الدوران + آلية الرفع			6,96	1,82	2,15	4180	
Tramo de pluma Jib section Tronçon de flèche Секция стрелы Vom bölümü أجزاء الذراع	P09 1R (I) P09 2R (II) P09 3R (III) P09 3F (IV) P09 5R (V) P09 5L (VI)		10,14 10,14 10,14 5,25 10,14 10,12	1 0,86 0,86 0,86 1,09 0,86	1,16 1,09 1,09 1,03 1,09 1,09	785 618 604 250 447 407	
Polipasto / Hook assembly / Palan / Полиспаст / Kanca takımı / بكرة	SR		0,76	0,17	0,96	140	
Carro Trolley / Chariot / Грузовая тележка / Şaryo / عربة	SR		1,00	1,39	0,77	125	
Contrapluma con plataformas / Counterjib with platforms Contre-flèche avec plateformes / Противовесная консоль с платформами / Platformlu kuçruk / الذراع المقابل مع المنصة			11,95	2,26	0,49	1410	
Plataforma y cabina / Platform and cabin / Plateforme et cabine Платформа и кабина / Platform ve kabin / منصة وكابينة			3,89	1,69	2,33	855	
Contrapeso / Counterweight / Contrepoids / Противовес Denge ağırlığı / اوزان معاكسة	Grande / Big / Grand / Большой / Büyük / كبير Pequeño / Small / Petit / Малый / Küçük / صغير		1,2 1,2	0,50 0,50	2,02 1,30	2360 1500	
Base grúa Testero largo Crane base Long carriage Base de la grue. Palonnier long Основание крана. Длинная передняя часть Vinç tabanı. Uzun vinç arabası قاعدة الرافعة مقدّمة طويلة (للكابينة)	BTX 38 BTX 38R BTX 45		6,11 6,11 7,01	0,64 0,64 0,64	1,53 1,57 1,57	1576 1792 2065	
	BTX 38L BTX 38RL BTX 45L		5,46 5,46 4,01	0,55 0,55 0,55	0,97 0,88 0,88	1160 850 660	
	BEX 38 BEX 38R BEX 45		5,56 5,56 6,55	0,3 0,3 0,3	1,27 1,40 1,41	1390 1590 1863	
	Mecanismo traslación grúa / Crane travelling mechanism Mécanisme de translation de la grue / Механизм перемещения крана / Yürüyüş mekanizmalı vinç / آلية رفع الرافعة			0,96	0,56	0,66	293
	Lastre Ballast / Lest / Балласт / Alt ağırlık taşları / ثقّل	3,8m - 4,5m		4,00	0,34	1,30	4100
		BE 442 BE 434		2,09	0,34	2,10	3450
Torre de montaje / Jacking cage / Tour de montage / Монтажная башня / Kaldırma kafesi / برج التركيب			7,14	1,76	1,71	3200	
Torre de montaje sin puerta, carro, plataforma carro y viga de apoyo Jacking cage without door, trolley, trolley platform and beam assembly Tour de montage sans porte, chariot, plateforme de chariot et poutre de soutien Монтажная башня без двери, грузовой тележки, платформы грузовой тележки и опорной балки Kapısız kaldırma kafesi, vinç köprüsü arabası, vinç köprüsü arabası platformu ve giriş takımı برج التركيب بدون بوابة ، وعربة ومنصة متحركة وعارضة تدعيم		TMU 1.18 	7,14	1,76	1,71	2450	



Fecha / Date: 20/01/2016

FEM 1005 - C25

Reservado el derecho a modificaciones sin previo aviso. Declinamos toda responsabilidad derivada de la información proporcionada / Subject to modification, without previous warning. This information is supplied without liability / L'entreprise se réserve le droit de procéder à des modifications sans préavis. Nous déclinons toute responsabilité quant aux informations fournies / Мы оставляем за собой право на внесение изменений без предварительного уведомления. Мы снимаем с себя любую ответственность в отношении предоставленной информации / Önceden bildirilmeksizin değiştirilme hakkı saklıdır. Verilen bilgiler için hiçbir sorumluluk kabul etmemekteyiz / حقوق التغيير محفوظة دون إشعار مسبق. دون أدنى مسؤولية عن المعلومات المقدّمة

T	H	Component	Height (m)	Weight (kg)
1	4,5	TN 4	4,5	146.32.000
2	8,5	TN 4	8,5	146.31.000
3	20,3	TN 12	20,3	146.30.000
4	32,2	TR 12	32,2	146.30.800
5	40,1	TR 8M	40,1	202.36.500
6	43,9	TX-90/TXXR	43,9	133.32.000
7	46,8	T 3-90	46,8	161.31.300
8	49,8	T6-150A	49,8	161.31.000
9	52,7	T6-150	52,7	161.36.000
10		TL20/TX150		161.36.000
11		TS20-5,6A		204.31.300
12		TS20-5,6		204.31.200
13		ASR 20		

AN 90 133.21.000
 AND 90 133.21.800
 AN 150 161.21.000
 AND 150 161.21.050
 AL 20 153.21.800
 ALD 20 160.21.250
 AS 20 160.21.010
 ASD 20/24 160.21.080
 ASR 20 160.21.200
 ASRD 20/24 156.21.000

T: Torre / Tower / Tour / Башни / Kuleler / أبراج
 H: Altura / Height / Hauteur / Высота / Yükseklik / ارتفاع

Transporte
 Transport / Transport /
 Транспортировка / Taşıma /
 نقل

H=38,4 + AN12

3x

3x HIGH CUBE 40'

≤ 6xTN4

TREPADO / CLIMBING / TÉLESCOPAGE / ЛЕСТНИЦА / TIRMANMA / التسلق J5510

$h_{max} = 3xTR4 + 6xTN4$

h (m)	36
D (m)	8,6 - 10
P (KN)	369 344
Rmax (KN)	98 252

TR4: 800.32.300

H < 200 m

Trepado interno / Internal climbing. / Télescopage intérieur / Внутренняя лестница /
 Bina içi tırmanma / التسلق الداخلي

- ⚠ Viento fuera de servicio / Out of service wind / Vitesse du vent hors service / Ветровая нагрузка в покое / Rüzgar devre dışı / الريح خارج الخدمة
- 📄 Consultar / Consult / Nous consulter / Консультируйтесь / Danışınız / الرجوع إلى
- ▶ En servicio / In service / En service / В работе / Devrede / في الخدمة
- Fuera de servicio / Out of service / Hors service / В покое / Devre dışı / خارج الخدمة



Ctra./Rd. Madrid - Irún Km. 415 - 20.213 IDIAZABAL [Gipuzkoa] ESPAÑA / SPAIN
 P.O. Box, 23 - 20.200 BEASAIN - E-mail: jaso@jaso.com
 Tel. +34 943 - 18 70 00 • Fax. +34 943 - 18 70 20
 www.jaso.com

Fecha / Date: 20/01/2016

FEM 1005 - C25

DELEGACION / DEALER

Reservado el derecho a modificaciones sin previo aviso. Declinamos toda responsabilidad derivada de la información proporcionada / Subject to modification, without previous warning. This information is supplied without liability / L'entreprise se réserve le droit de procéder à des modifications sans préavis. Nous déclinons toute responsabilité quant aux informations fournies / Мы оставляем за собой право на внесение изменений без предварительного уведомления. Мы снимаем с себя любую ответственность в отношении предоставленной информации / Önceden bildirilmesizin değiştirilme hakkı saklıdır. Verilen bilgiler için hiçbir sorumluluk kabul etmemekteyiz /

حقوق التغيير محفوظة دون إشعار مسبق. دون أدنى مسؤولية عن المعلومات المقدمة