

**GRUA TORRE / TOWER CRANE**

GRUE A TOUR / БАШЕННЫЙ КРАН /  
رافعة برجية / KULE VINÇ

# J5010



EN 14439  
C25

UNE-EN-ISO 9001

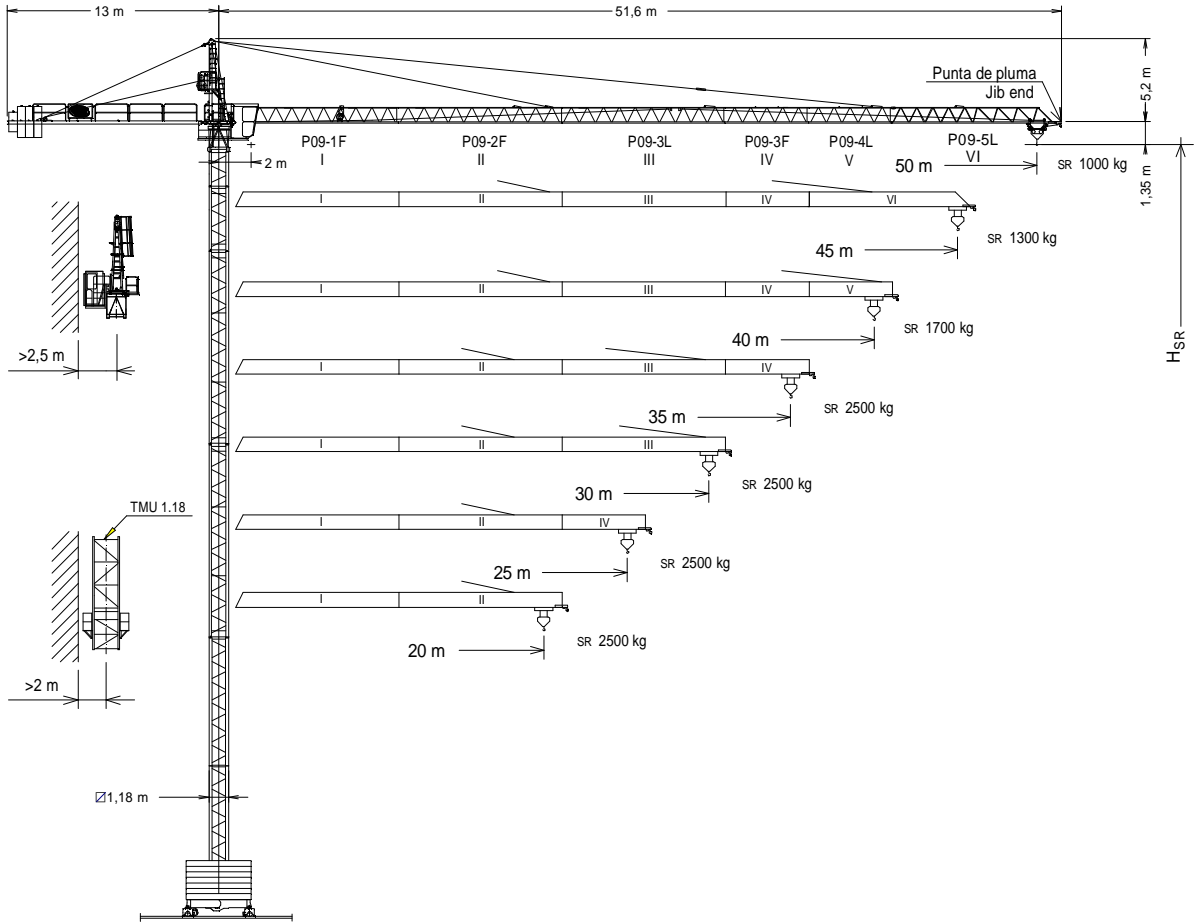

<p>Altura máxima bajo gancho sin arriostrar (m). Maximum height under hook without fastening (m). Hauteur maximale sous crochet sans ancrage (m). Максимальная высота под крюком без крепления (m). Bağlantısız maksimum kanca altı yüksekliği (m). أقصى ارتفاع تحت الخطاف بدون ربط (m)</p> <p><math>H_{SR} =</math></p> <p> <math>H_{SR} - 2 m.</math></p>	TMU 1.18	202.35.500	TN 4	146.32.000
	P09-1F	157.40.000	TN2	146.32.500
	P09-2F	157.41.000	BTX 45/BEX 45	137.20.500
	P09-3L	155.42.000	BTX 38R/BEX 38R	137.20.000
	P09-3F	157.43.000	BTX 38/BEX 38	149.20.000
	P09-4L	155.43.000	BEX 45L	155.23.500
	P09-5L	155.44.500	BEX 38RL	155.23.800
	Punta de pluma / Jib end*	155.45.000	BEX 38L	155.23.000
	TR 12	146.30.000	ABH 75	152.23.000
	TN 12	146.31.000	ABH 90	146.23.000
	TR 8RM	202.30.000	AR 12	137.21.000
TR 8M	146.30.800	AN 12	146.21.000	
TR 4	800.32.300	BE 442	146.24.850	

\* Punta de pluma / Jib end / Pointe de flèche / Конеч стрелы / Ворот усу / مقدمة الذراع

(H) TRASLACIÓN / TRAVELLING /



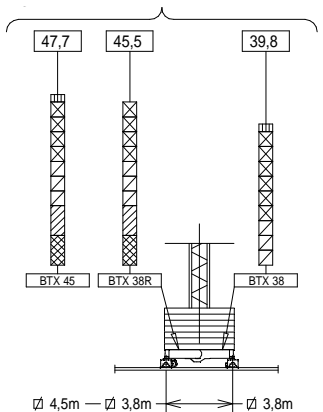



TRASLATION / ПЕРЕМЕЩЕНИЕ / RAY YÜRÜYÜŞLÜ / متحركة

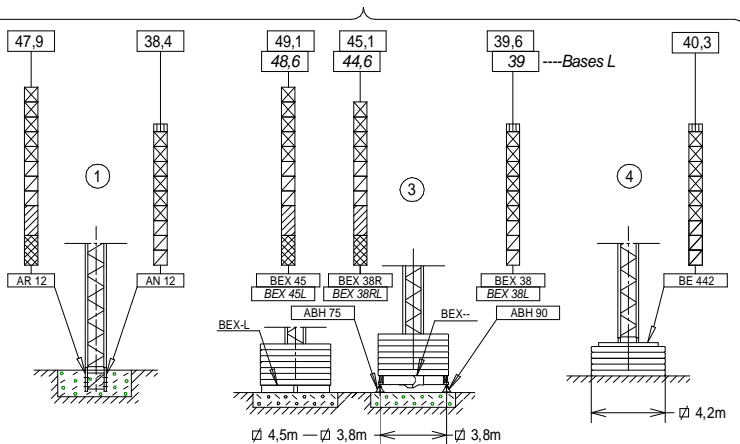

(H) ESTACIONARIA / STATIONARY /

STATIONAIRE / СТАЦИОНАРНОЕ СОСТОЯНИЕ / SABIT / ثابتة



-  TN 2
-  TR 8RM
-  TR 8M
-  TN 4
-  TN 12
-  TR 4
-  TR 12





Fecha / Date: 20/01/2016



Reservado el derecho a modificaciones sin previo aviso. Declinamos toda responsabilidad derivada de la información proporcionada / Subject to modification, without previous warning. This information is supplied without liability / L'entreprise se réserve le droit de procéder à des modifications sans préavis. Nous déclinons toute responsabilité quant aux informations fournies / Мы оставляем за собой право на внесение изменений без предварительного уведомления. Мы снимаем с себя любую ответственность в отношении предоставленной информации / Önceden bildirilmeksizin değiştirilme hakkı saklıdır. Verilen bilgiler için hiçbir sorumluluk kabul etmemekteyiz











**CARGAS / LOADS / CHARGES / НАГРУЗКИ / YÜKLER / الأحمال** **J5010**

 SR1 (kg)		Cargas máximas / Maximum loads / Charges maximales / Максимальные нагрузки / Maksimum yük / أقصى حمولة <b>SR1-2000 kg</b>						
 [m]	2000 kg @...[m]	Alcance del gancho [m] / Hook reach [m] / Portée du crochet (m) / Радиус действия крюка (m) / Kancanın yüksekliği (m) / مدى الخطاف						
		<b>20</b>	<b>25</b>	<b>30</b>	<b>35</b>	<b>40</b>	<b>45</b>	<b>50</b>
<b>50 m</b>	27,3	2000	2000	1800	1515	1300	1135	1000
<b>45 m</b>	30,9	2000	2000	2000	1730	1490	1300	—
<b>40 m</b>	34,5	2000	2000	2000	1970	1700	—	—
<b>35 m</b>	35,0	2000	2000	2000	2000	—	—	—
<b>30 m</b>	30,0	2000	2000	2000	—	—	—	—
<b>25 m</b>	25,0	2000	2000	—	—	—	—	—
<b>20 m</b>	20,0	2000	—	—	—	—	—	—



**CARGAS / LOADS / CHARGES / НАГРУЗКИ / YÜKLER / الأحمال** **J5010**

 SR2 (kg)		Cargas máximas / Maximum loads / Charges maximales / Максимальные нагрузки / Maksimum yük / أقصى حمولة <b>SR2-2500 kg</b>						
 [m]	2500 kg @...[m]	Alcance del gancho [m] / Hook reach [m] / Portée du crochet (m) / Радиус действия крюка (m) / Kancanın yüksekliği (m) / مدى الخطاف						
		<b>20</b>	<b>25</b>	<b>30</b>	<b>35</b>	<b>40</b>	<b>45</b>	<b>50</b>
<b>50 m</b>	22,2	2500	2200	1800	1515	1300	1135	1000
<b>45 m</b>	25,0	2500	2500	2050	1730	1490	1300	—
<b>40 m</b>	28,1	2500	2500	2335	1970	1700	—	—
<b>35 m</b>	35,0	2500	2500	2500	2500	—	—	—
<b>30 m</b>	30,0	2500	2500	2500	—	—	—	—
<b>25 m</b>	25,0	2500	2500	—	—	—	—	—
<b>20 m</b>	20,0	2500	—	—	—	—	—	—

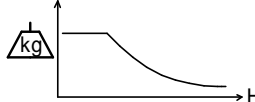
**CARACTERÍSTICAS DE MECANISMOS / MECHANISMS FEATURES** **J5010**

<b>CARACTÉRISTIQUES DES MÉCANISMES / ХАРАКТЕРИСТИКИ МЕХАНИЗМОВ / MEKANİZMALARIN ÖZELLİKLERİ / الخصائص الآلية</b>											
*opcional *optional *en option *опция *opsiyonel *اختياري	<b>EC1846 SR2 13,2 kW</b>	<b>EC1856 SR1 13,2 kW</b>	<b>*EC2566VF SR2 18,4 kW</b>	<b>*EC2580VF SR1 18,4 kW</b>	<b>☑ 2,8/3,8 / 4,5m TG825VF 2x3 kW</b>	<b>OG708VF 5,5 kW</b>	<b>TC360 / *TC360VF 1,9 / *1,8 kW</b>	<b>TH1010 9,2 kW</b>			
 m/min	1,3   2,5   2,5 46   23   5	1,1   2   2 56   28   6	1,3   2,5 0..64   0..32	1,1   2 0..82   0..41	0...25 m/min	0...0,8 r/min sl/min	30/60 m/min *0...30 *30...60 m/min	1 m/min			
 H	H ≤ SR 193 m		SR 189 m		<b>⚡ P<sub>TOTAL</sub> (EC1846/EC1856 + OG708VF + TC360) = 20,6 Kw</b> 400V 50Hz		<b>P<sub>TOTAL</sub> (*EC2566VF/*EC2580VF + OG708VF + *TC360VF) = *25,7 Kw</b>				
					<b>⚡ 480V 60Hz</b>		EC1846 EC1856 TC360 TH1010		kW +20% m/min +20%		

**LASTRES INFERIORES / LOWER BALLASTS / LESTS INFÉRIEURS / НИЖНИЙ БАЛЛАСТ / ALT AĞIRLIK TAŞLARI / نقل** **J5010**

		<b>H (m)</b>		<b>18</b>	<b>22</b>	<b>30</b>	<b>40</b>	<b>47,7</b>	<b>49,1</b>
<b>BEX 45 / BTX 45</b>		 4100 kg		6		8	10	14	16
<b>BEX45L</b>				8		10	14	16	
<b>BEX 38R / BTX 38R</b>				6	8	10	12	16	6
<b>BEX 38 / BTX 38</b>				6	8	10	12	----	
<b>BEX 38RL</b>				8		10	12	16	----
<b>BEX 38L</b>				8		10	12	----	
		<b>H (m)</b>		31,9			40,3		
<b>BE 442</b>		 3450 kg		16		20			



H: Altura bajo gancho / Height under hook / Hauteur maximale sous crochet / Высота под крюком / Kanca altı yüksekliği / الارتفاع أسفل الخطاف  
 Para alturas intermedias tomar el lastre correspondiente a la altura superior / For intermediate heights take the ballast corresponding to the higher height / Pour les hauteurs intermédiaires, opter pour le lest correspondant à la hauteur immédiatement supérieure / Для промежуточных высот возьмите балласт, соответствующий большей высоте / Orta yükseklikler için daha üst bir yüksekliğe karşılık gelen ağırlığı alınız. / استخدام النقل العائد للارتفاع الأعلى / لارتفاعات البيئية يرجى استخدام النقل العائد للارتفاع الأعلى

Fecha / Date: 20/01/2016

 **FEM 1005 - C25**

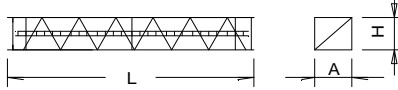
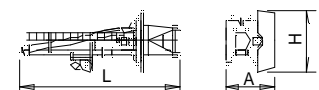
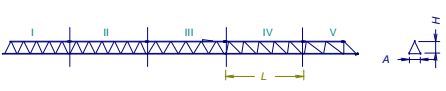
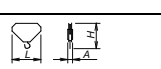

Reservado el derecho a modificaciones sin previo aviso. Declinamos toda responsabilidad derivada de la información proporcionada / Subject to modification, without previous warning. This information is supplied without liability / L'entreprise se réserve le droit de procéder à des modifications sans préavis. Nous déclinons toute responsabilité quant aux informations fournies / Мы оставляем за собой право на внесение изменений без предварительного уведомления. Мы снимаем с себя любую ответственность в отношении предоставленной информации / Önceden bildirilmeksizin değiştirilme hakkı saklıdır. Verilen bilgiler için hiçbir sorumluluk kabul etmemekteyiz / حقوق التغيير محفوظة دون إشعار مسبق. دون أدنى مسؤولية عن المعلومات المقدمة

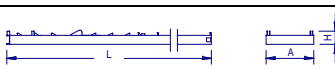
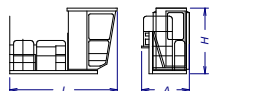
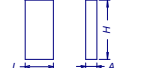
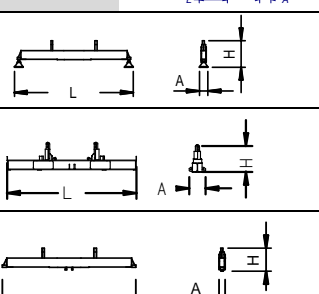
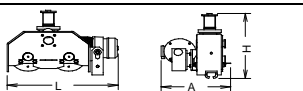
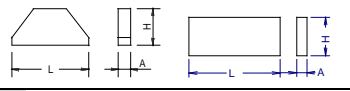
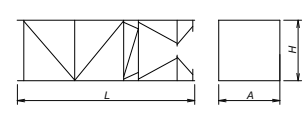
DENOMINACIÓN / DENOMINATION / DÉSIGNATION / НАЗВАНИЕ / AÇIKLAMA / اسم		L [m]	A [m]	H [m]	P / W [kg]
Torre Tower Tour Башня Kule برج	TR 8RM – TR 8M TR 12 – TN 12 TR 4 TN 4 TN 2				2575-2515 2840-2780 1070 1055 785
Conjunto asiento pista, punta de torre, orientación y elevación Slewing table assembly, tower head, slewing and hoisting mechanism Groupe pivot + porte-flèche + mécanisme d'orientation + de levage Сиденье площадки + верхняя секция башни + поворотный механизм + подъемный механизм Göbek +kulenin kafa bölümü+mekanizma+vinç kulesi مجموعة وحدة الدوارن + رأس البرج + آلية الدوران + آلية الرفع					4090
Tramo de pluma Jib section Tronçon de flèche Секция стрелы Vom bölümü أجزاء الذراع	P09 1F (I) P09 2F (II) P09 3L (III) P09 3F (IV) P09 4L (V) P09 5L (VI)				705 560 565 235 250 407
Polipasto / Hook assembly / Palan / Полупастак / Kanca takımı / بكرة	SR				135
Carro / Trolley / Chariot / Грузовая тележка / عربة / Şaryo	SR				110
Contrapluma con plataformas / Counterjib with platforms Contre-flèche avec plateformes / Противовесная консоль с платформами / Platformlu kuyruk / الذراع المقابل مع المنصة					942
Plataforma y cabina / Platform and cabin / Plateforme et cabine Платформа и кабина / Platform ve kabin / منصة وكابينة					820
Contrapeso / Counterweight / Contrepoids / Grande / Big / Grand / Большой / Büyük / كبير Противовес / Denge ağırlığı / موازن معاكسة / Pequeño / Small / Petit / Малый / Küçük / صغير					2360 1500
Base grúa Testero largo Crane base Long carriage Base de la grue. Palonnier long Основание крана. Длинная передняя часть Vinç tabanı. Uzun vinç arabası قاعدة الرافعة مقدمة طويلة (للكابينة)	BTX 38 BTX 38R BTX 45 BTX 38L BTX 38RL BTX 45L BEX 38 BEX 38R BEX 45				1576 1792 2065 1160 850 660 1390 1590 1863
Mecanismo traslación grúa / Crane travelling mechanism Mécanisme de translation de la grue / Механизм перемещения крана / Yürüyüş mekanizmalı vinç / آلية رفع الرافعة					293
Lastre / Ballast / Lest / Балласт / Alt ağırlık taşları / ثقل	□ 2,8m □ 3,8m - □4,5m BE 442 BE 434				3700 4100 3450 4300
Torre de montaje / Jacking cage / Tour de montage / Монтажная башня / Kaldırma kafesi / برج التركيب					3200
Torre de montaje sin puerta, carro, plataforma carro y viga de apoyo Jacking cage without door, trolley, trolley platform and beam assembly Tour de montage sans porte, chariot, plateforme de chariot et poutre de soutien Монтажная башня без двери, грузовой тележки, платформы грузовой тележки и опорной балки Kapisız kaldırma kafesi, vinç köprüsü arabası, vinç köprüsü arabası platformu ve giriş takımı برج التركيب بدون بوابة ، وعربة ومنصة متحركة وعارضة تدعيم	TMU 1.18				2450

T	H								H	T		
1	4,5	TN 4							TN 4	146.32.000	4,5	1
2	8,5	TN 4							TN 4		8,5	2
3	20,3	TN 12							TN 12	146.31.000	20,3	3
4	32,2	TR 12							TR 12	146.30.000	32,2	4
5	40,1	TR 8M							TR 8M	146.30.800	40,1	5
6	43,9	T 3-90							TX-90/TXXR	202.36.500	43,9	6
7	46,8								T 3-90	133.32.000	46,8	7
8	49,8								T6-150A	161.31.300	49,8	8
9	52,7								T6-150	161.31.000	52,7	9
		AN 90	133.21.000						TL20/TX150	161.36.000		10
		AN 90	133.21.800						TL20-5,6	204.31.400		11
		AN 150	161.21.000						TS20-5,6A	204.31.500		12
		AN 150	161.21.050						TS20-5,6	204.31.200		13
		AL 20	153.21.800						ASR 20			14
		ALD 20	160.21.250									
		AS 20	160.21.010									
		ASD 20/24	160.21.080									
		ASR 20	160.21.200									
		ASRD 20/24	156.21.000									

T: Torre / Tower / Tour / Башни / Kuleler / أبراج  
 H: Altura / Height / Hauteur / Высота / Yükseklik / ارتفاع

Transporte  
 Transport / Transport /  
 Транспортировка / Taşıma /  
 نقل

H=38,4 + AN12

2x

3x HIGH CUBE 40'

≤ 6xTN4

TREPADO / CLIMBING / TÉLESCOPAGE / ЛЕСТНИЦА / TIRMANMA / التسلق

J5010

h<sub>max</sub>: 3xTR4 + 6xTN4

	▶	■
h (m)	36	
D (m)	9,1 - 10	
P (KN)	342	317
R <sub>max</sub> (KN)	92	250

TR4: 800.32.300

Trepado interno / Internal climbing. / Télescopage intérieur / Внутренняя лестница /  
 Bina içi tırmanma / التسلق الداخلي

- ⚠ Viento fuera de servicio / Out of service wind / Vitesse du vent hors service / Ветровая нагрузка в покое / Rüzgar devre dışı / الريح خارج الخدمة
- 📄 Consultar / Consult / Nous consulter / Консультируйтесь / Danışınız / الرجوع إلى
- ▶ En servicio / In service / En service / В работе / Devrede / في الخدمة
- Fuera de servicio / Out of service / Hors service / В покое / Devre dışı / خارج الخدمة



Ctra./Rd. Madrid - Irún Km. 415 - 20.213 IDIAZABAL [Gipuzkoa] ESPAÑA / SPAIN  
 P.O. Box, 23 - 20.200 BEASAIN - E-mail: jaso@jaso.com  
 Tel. +34 943 - 18 70 00 • Fax. +34 943 - 18 70 20  
**www.jaso.com**

Fecha / Date: 20/01/2016

FEM 1005 - C25

DELEGACION / DEALER

Reservado el derecho a modificaciones sin previo aviso. Declinamos toda responsabilidad derivada de la información proporcionada / Subject to modification, without previous warning. This information is supplied without liability / L'entreprise se réserve le droit de procéder à des modifications sans préavis. Nous déclinons toute responsabilité quant aux informations fournies / Мы оставляем за собой право на внесение изменений без предварительного уведомления. Мы снимаем с себя любую ответственность в отношении предоставленной информации / Önceden bildirilmesizin değiştirilme hakkı saklıdır. Verilen bilgiler için hiçbir sorumluluk kabul etmemekteyiz /

حقوق التغيير محفوظة دون إشعار مسبق. دون أدنى مسؤولية عن المعلومات المقدمة